

A wide-angle photograph of a modern office space. The room features a grid ceiling with recessed rectangular light fixtures. The floor is a light-colored, polished surface. In the foreground and middle ground, there are several light-colored wooden desks arranged in rows. Each desk is equipped with a blue fabric privacy screen and a white ergonomic office chair. The desks are separated by glass partitions with black frames. In the background, there are more desks, some with wooden cabinets underneath, and a large window on the left side. The overall atmosphere is clean, bright, and professional.

**GUNDI**

## GUNDI | incasso, plafone



Gundi incasso opale o UGR

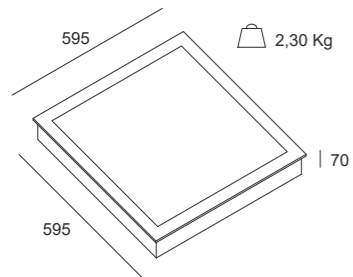

Gundi plafone opale o UGR

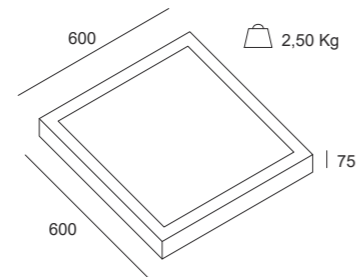

### GUNDI | incasso, plafone

Watt*	Lumen**	K	Emissione
24W	3500	3000 K 4000 K 5000 K	Wide (119°)
32W	4600		
40W	5700		
47W	6800		

P. Stand-by: 0 | P. Stand-by in rete: 0 | Int. Elettrica: 230 Vac 50Hz  
 \*Potenza dei LED \*\*Flusso totale in uscita dall'apparecchio @Tamb 25° - 4000°K  
 Considerare una riduzione del flusso in uscita dell'8% per sorgente LED 3000°K

#### Colori



#### Caratteristiche



#### A richiesta:



## GUNDI arretrata | incasso



Gundi arretrata incasso

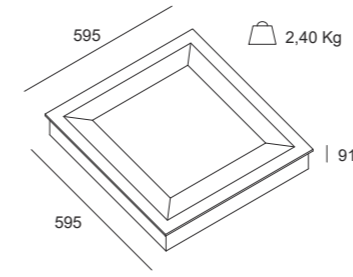

### GUNDI arretrata | incasso

Watt*	Lumen**	K	Emissione
39W	5160	3000 K 4000 K 5000 K	Wide (119°)

P. Stand-by: 0 | P. Stand-by in rete: 0 | Int. Elettrica: 230 Vac 50Hz  
 \*Potenza dei LED \*\*Flusso totale in uscita dall'apparecchio @Tamb 25° - 4000°K  
 Considerare una riduzione del flusso in uscita dell'8% per sorgente LED 3000°K

#### Colori



#### Caratteristiche



#### A richiesta:





## GUNDI line | incasso



Gundi line incasso UGR

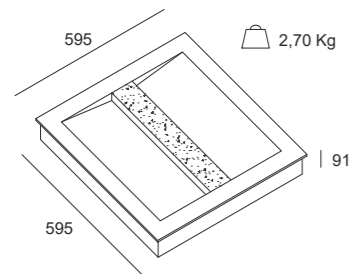

### GUNDI line | incasso

Watt*	Lumen**	K	Emissione
25,5W	3430	3000 K 4000 K	Wide (119°)

P. Stand-by: 0 | P. Stand-by in rete: 0 | Int. Elettrica: 230 Vac 50Hz  
 \*Potenza dei LED \*\*Flusso totale in uscita dall'apparecchio @Tamb 25° - 4000°K  
 Considerare una riduzione del flusso in uscita dell'8% per sorgente LED 3000°K

#### Colori



#### Caratteristiche



#### A richiesta:



## GUNDI line double | incasso

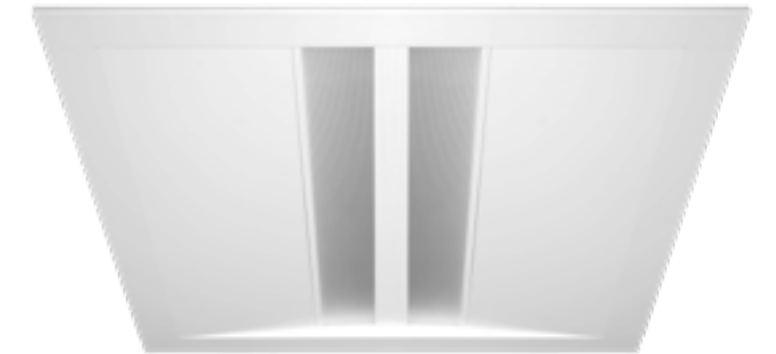

Gundi line double incasso UGR

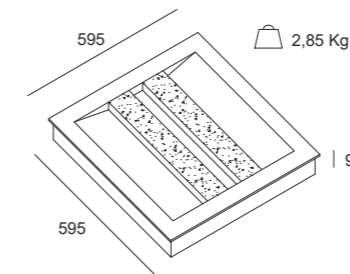

### GUNDI line double | incasso

Watt*	Lumen**	K	Emissione
38W	5520	3000 K 4000 K	Wide (119°)
42W	5920		

P. Stand-by: 0 | P. Stand-by in rete: 0 | Int. Elettrica: 230 Vac 50Hz  
 \*Potenza dei LED \*\*Flusso totale in uscita dall'apparecchio @Tamb 25° - 4000°K  
 Considerare una riduzione del flusso in uscita dell'8% per sorgente LED 3000°K

#### Colori



#### Caratteristiche



#### A richiesta:



# GUNDI line 295x1195 | incasso



Gundi line 295x1195 incasso UGR

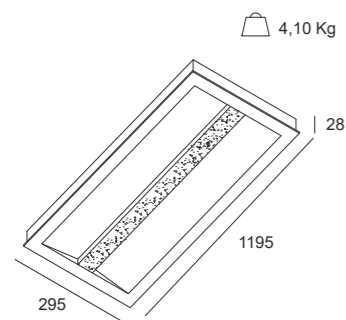

## GUNDI line 295x1195 | incasso

Watt*	Lumen**	K	Emissione
26W	3670	3000 K 4000 K	Wide (119°)

P. Stand-by: 0 | P. Stand-by in rete: 0 | Int. Elettrica: 230 Vac 50Hz  
 \*Potenza dei LED \*\*Flusso totale in uscita dall'apparecchio @Tamb 25° - 4000°K  
 Considerare una riduzione del flusso in uscita dell'8% per sorgente LED 3000°K

### Colori



### Caratteristiche



### A richiesta:

